



UDI023/UDI023PRO

OPERATING INSTRUCTIONS

Suitable for sailing in larger waters

V2.0

Note

- ▲ This product is suitable for users over 14 years old.
- ▲ Stay away from the rotating propeller.
- ▲ Read the “important statement and safety guidelines” carefully.
<https://udirc.com/disclaimer-and-safety-instructions>



Li-Po Battery Disposal & Recycling

Wasted Lithium-Polymer batteries must not be placed with household trash. Please contact local environmental or waste agency or the supplier of your model or your nearest Li-Po battery recycling center.



Important Notice

Our company's products are improving all the time, design and specifications are subject to change without notice. All the information in this manual has been carefully checked to ensure accuracy, if any printing errors, our company reserve the final interpretation right.

Preparation the boat

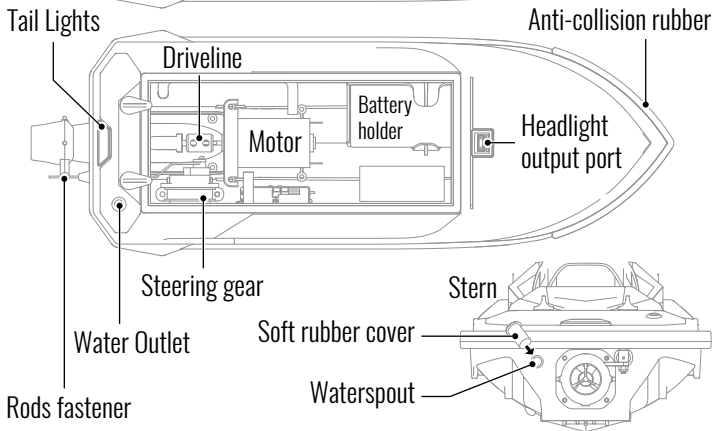
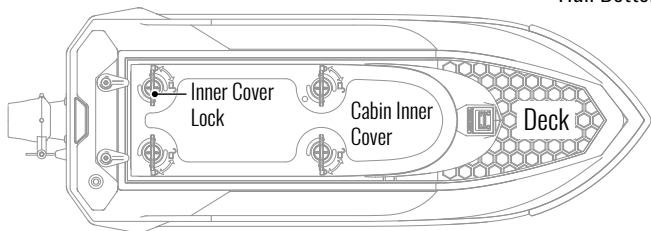
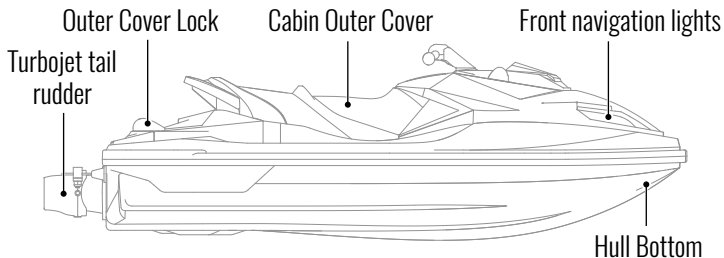

Battery Charge

Connect the charging case to the charging input port of the boat battery and then connect the USB output ports. The green indicator light flashes when charging and the green indicator light will keep bright fully charged. During the charging, battery should not be placed in the hull when charging and must be cooled before charging.

Battery input port

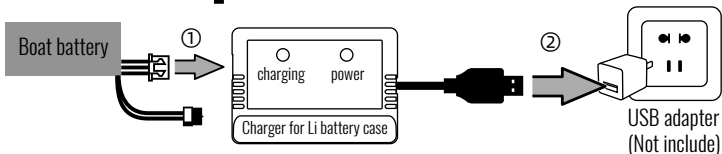

WARNING: MUST BE SUPERVISED WHILE CHARGING.
Please use the included charging case and make sure it is properly connected.

Boat Battery Installation Method

1) Twist to left or right to open the outer cover lock. open up the cabin cover.

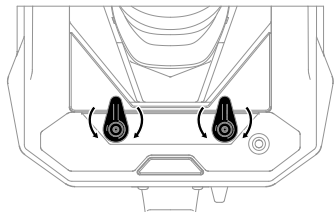

2) According to the mark on the surface of the inner cover, unlock the lock and take out the inner cover upward.

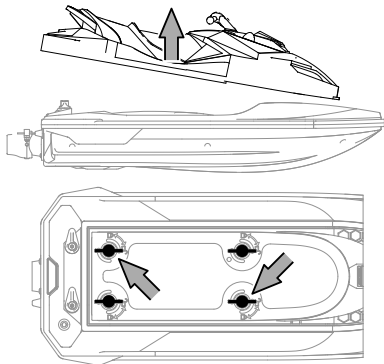

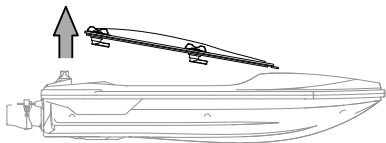

3) Put the boat-battery into the boat battery holder and properly connected the hull input port.

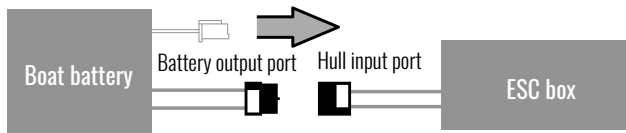
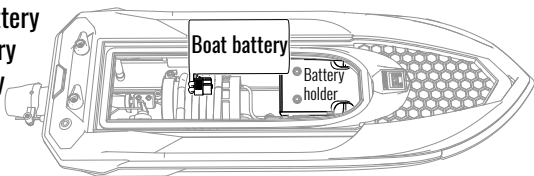

4) Cover the cabin and lock tightly.

Noted:

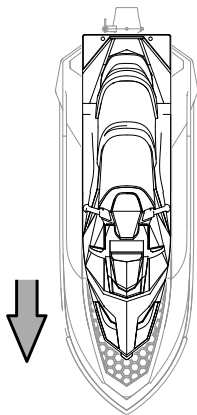

- The battery wires need to put aside of the boat to avoid tangled or broken off by the rudder wheels.
- If there is a few boats to play together, you need to code pairing one by one, and can not do it at the same time to avoid improper operation and cause danger.
- At the end of playing, turn the bow of the boat straightdown and then open the cover to prevent water from flowing back into the cabin.

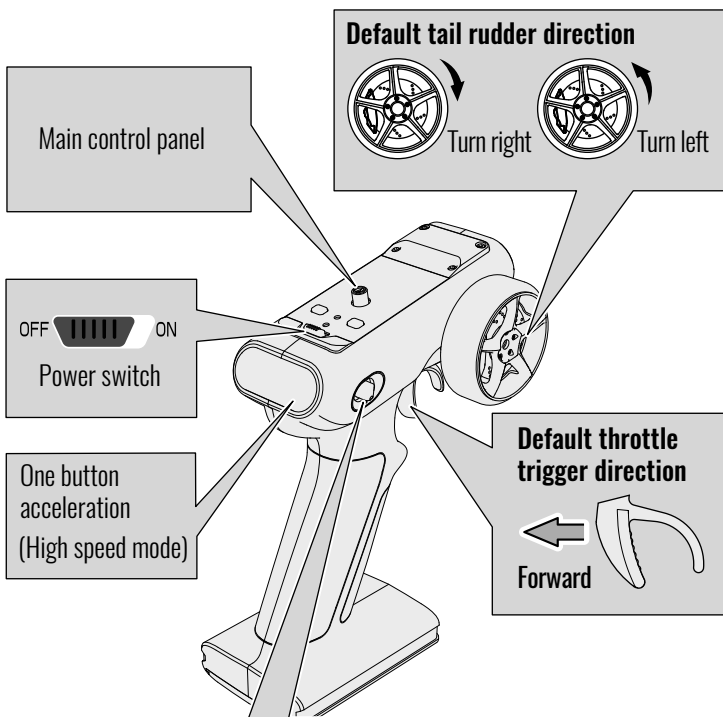

Transmitter Preparation



Throttle speed limit switch

-  High speed mode: Throttle output limited to 50%.
-  Medium speed mode: Throttle output limited to 75%.
-  Low speed mode: 100% throttle output.

Introduction of main interface function

Steering trim



ST.TRIM
Tail trim



The knob turns to the right when the boat is turn to left.



The knob turns to left when the boat is turn to right.



When the steering wheel is in the center position, if the model cannot sail in a straight line, please use the steering adjustment knob to adjust the left and right direction of the hull.

Capsize recover

Press the button when the boat on full charge, the boat will automatically return to the right position



ST.TRIM

RX

TX



Light control

Press this button to turn headlight and the taillights on/off at the same time.

Boat status indicator (green)

When the battery of cars is in low battery, the indicator light will flash. It remind operator to replace the battery as soon as possible to avoid accidents.

Transmitter indicator (red)

When the signal is weak or interrupted, the indicator will flash quickly. When the power of the transmitter is low, the indicator light will flash slowly. The above situation should be handled as soon as possible to avoid accidents.

Battery installation of transmitter

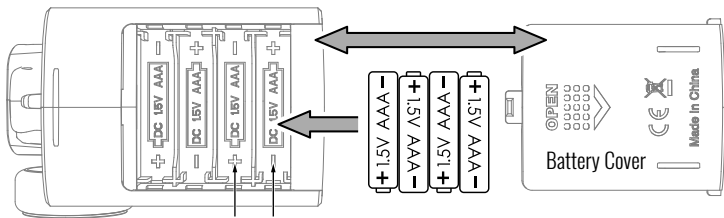

! Note Direction 1.5V×4 AAA Batteries(not included)

Open battery cover at the bottom of transmitter. Install batteries. Follow the direction of batteries designated in the inside of the battery box.

Frequency matching

1) Power on the transmitter, will sound "di", and the red indicator light flashes.

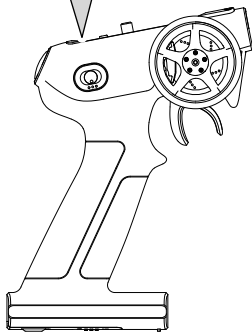

Do not touch the throttle trigger when turning on the power of the transmitter.

Please make sure the transmitter throttle trigger and Steering wheel to normal.

- 2) Connected the boat battery, the transmitter will sound "didi", it means frequency pairing successful.
- 3) Tighten the hatch cover.

It is recommended to be familiar with the operation on the surface of the water before long distance navigation.

Ready before sailing

- 1) The silicone tube of the water cooling system cannot be folded and must be kept unblocked.
- 2) When the steering wheel turns counterclockwise, the turbojet tail rudder swings to the left; When turning clockwise, the jet tail rudder swings on the right.
- 3) Make sure that the boat cover is locked up and buckled.

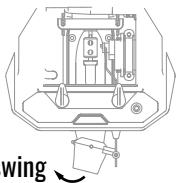

Left swing

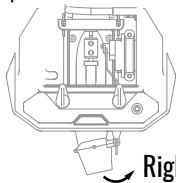

Right swing

Throttle Steering

Throttle trigger

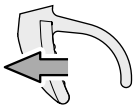

Go forward



Throttle trigger

Steering wheel

Throttle trigger

Steering wheel

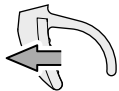

+



Go forward

Turn left

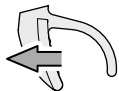

+



Go forward

Turn right



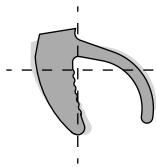

Pull the throttle trigger back gently and the boat will move forward slowly.

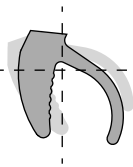

The throttle trigger is pulled to the maximum, and the boat moves forward quickly.

Water cooling system

The motor lowers the temperature by flowing water. During the voyage, water flows through the heat pipe around the motor, which has a cooling effect on the motor.

Replac the steering gear

Disassembly: Turn off the power of boat

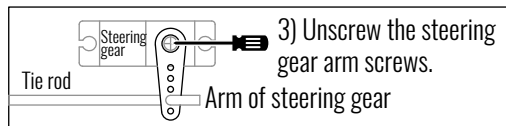

4) The steering gear is separated from the steering gear arm.

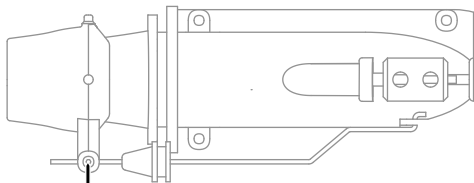

1) Unscrew tie rod assembly screws.

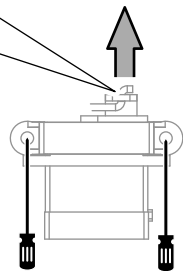

2) Unscrew steering gear and fixing screws and then take out fixing parts.

Installation: After the new steering gear is powered on, the disassembly sequence is operated in the opposite direction during installation.

Replace the steering gear with powered on, please noted the propeller turns unexpectedly.

Safety Precautions

- 1) Turn on the transmitter power first and then turn on the boat power before playing; Turn off the boat power first and then turn off the transmitter power when finish playing.
- 2) Make sure the connection is solid between battery and motor etc. The ongoing vibration may cause bad connection of power terminal.
- 3) Improper operation may cause damage to the hull or damage to the turbojet tail rudder.
- 4) It is forbidden to sail in the water where people are useful and sail away from salt water and sundry water.
- 5) The battery must be take out after playing to keep the cabin dry and clean.

Troubleshooting Guide

Problem	Solution
The transmitter indicator light is off	1) Replace the transmitter battery.
	2) Please make sure the battery is installed correctly.
	3) Please make sure the battery is installed correctly.
Unable to frequency	1) Make sure signal interference nearby and keep away.
	2) Operate the boat step by step in accordance with the user manual.
	3) The electronic component is damaged for frequent crash.
The boat is under-powered or can not go forward	1) Make sure whether the propeller is damaged or replace a new one.
	2) When the battery is low, charger it in time. Or replace it with a new battery.
	3) If the contact is poor, please remove the power plug and reinsert it.
	4) There are foreign objects inside the turbojet
The boat tilts to one side	1) Please make sure the steering arm is vertical and correct it.
	2) Please make sure the tail rudder is vertical and correct it.
	3) The steering gear is damaged, replace a new one.

FCC Note

This equipment has been tested and found to comply with the limits for a Class B digital device, pursuant to Part 15 of the FCC Rules. These limits are designed to provide reasonable protection against harmful interference in a residential installation. This equipment generates uses and can radiate radio frequency energy and, if not installed and used in accordance with the instructions, may cause harmful interference to radio communications. However, there is no guarantee that interference will not occur in a particular installation. If this equipment does cause harmful interference to radio or television reception, which can be determined by turning the equipment off and on, the user is encouraged to try to correct the interference by one or more of the following measures:

- *Reorient or relocate the receiving antenna.*
- *Increase the separation between the equipment and receiver.*
- *Connect the equipment into an outlet on a circuit different from that to which the receiver is connected.*

WARNING: Changes or modifications not expressly approved by the party responsible for compliance could void the user's authority to operate the equipment.

FCC Notice

The equipment may generate or use radio frequency energy. Changes or modifications to this equipment may cause harmful interference unless the modifications are expressly approved in the instruction manual. Modifications not authorized by the manufacturer may void user's authority to operate this device.

This device complies with Part 15 of the FCC Rules. Operation is subject to the following two conditions:

(1) This device may not cause harmful interference. (2) This device must accept any interference received, including interference that may cause undesired operation.

FCC Radiation Exposure Statement

The device has been evaluated to meet general RF exposure requirement.
The device can be used in portable exposure condition with out restriction.

WARNING

Warning: The product should only be used by adults and children over 14 years.

Adult supervision is required for children under 14 years.

Hinweis: Dieses Produkt ist für die Erwachsene und die Kinder ab 14 Jahren.

Die Kinder unter 14 Jahren müssen von Erwachsenen beaufsichtigt werden.

Avertissement: Ce produit est destiné aux adultes et aux enfants de plus de 14 ans.

Les enfants de moins de 14 ans doivent être surveillés par des adultes.

Avvertimento: Questo prodotto è destinato all'uso per i adulti e bambini di età superiore ai 14 anni.

I bambini di età inferiore ai 14 anni devono essere sorvegliati da un adulto.

Advertencia: Este producto es para adultos y niños mayores de 14 años.

Los niños menores de 14 años deben ser supervisados por adultos.

警告: この製品は、大人と14歳以上の子供には使用対象です。

14歳未満の子供は大人の監視が必要です。

آماع 14 نس قوف لافطال او ني غل ابل لبق نم طقف چت نمل مادختسا بجي ريذحت

آماع 14 نس نود لافطال لبولطم رابكل فارشا



DANGER!

Only suitable for age 14+



Manufacturer: SHANTOU CITY UDIRC TECHNOLOGY CO., LTD

Address: Guangfeng Industrial Zone, Guangyi Street, Chenghai District, Shantou City, Guangdong Province, CN

MADE IN CHINA